

BOLD
by
bürotime

teknik doküman





Bold, yoğun çalışma ortamlarında ergonomik özellikleri ile güçlü bir performans sergiler. Standartların üzerinde genişliğe sahip oturma minderi, 4 noktada limitlenebilen font derinlik ayarı sayesinde konforlu bir oturma deneyimi sunar.

Nefes alabilen file sırt yapısı ve ideal duruşu destekleyen sırt desteği yoğun ve uzun saatler boyunca çalışanlar için idealdir. Ayarlanabilir boyun desteği, kullanıcıya kişiselleştirilmiş konfor sağlar. Sertliği ayarlanabilir sırt yapısı, 3 ayrı noktada kilitleyerek sağlıklı hareketi teşvik eder.

ürün ailesi



yönetici



operasyonel

ürün özellikleri



ergonomik boyun desteği:
30 cm genişlikteki eğimli boyun desteği kullanıcının boynuna uyum sağlar.



2D kolçak:
yükseklik ve derinlik ayarı sağlar.



PU kolçak pedi dayanıklılık ve konfor sağlar.



bel desteği:
elastik file, yükseklik ayarlı bel desteği (50mm).



mekanizma:
kızaklı senkron mekanizma, 3 noktadan kilitleme, 4 noktalı kızaklı font derinlik ayarı, ayarlanabilir sırt sertlik ayarı.



ürün özellikleri



ölçü tablosu

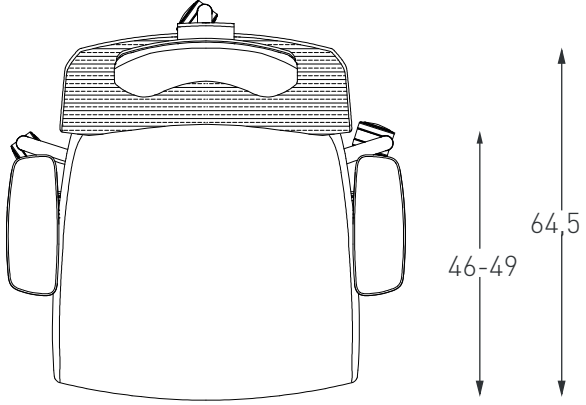
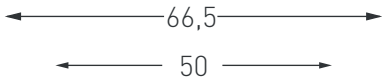
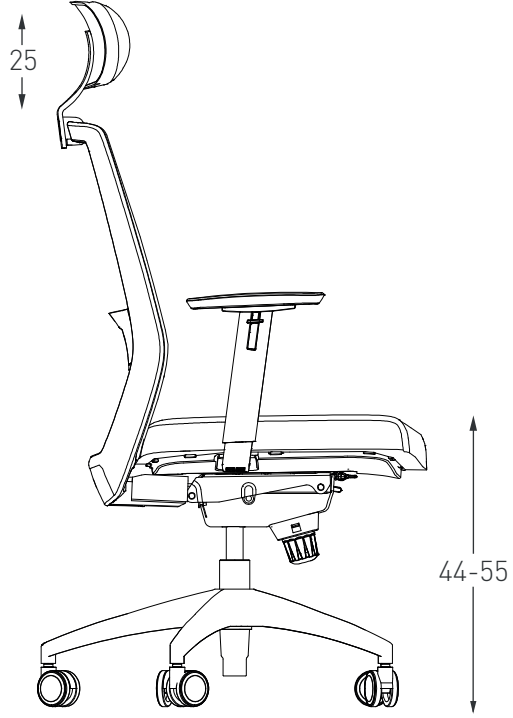
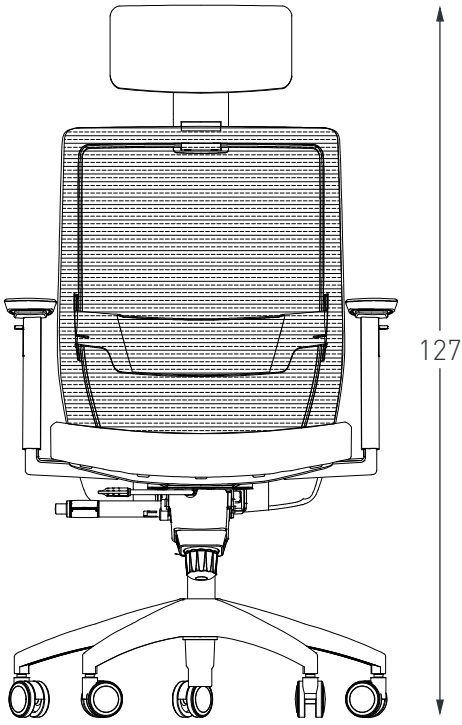

ölçü tablosu _____

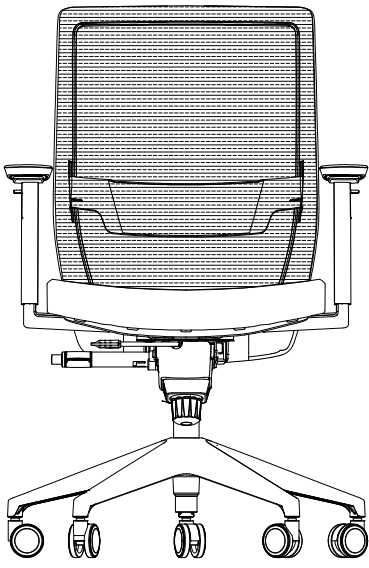

107

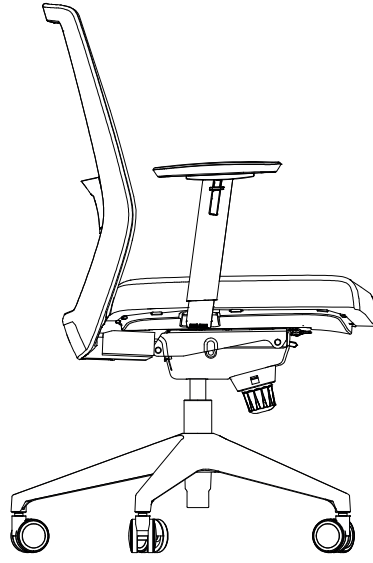

45-55

66,5

50

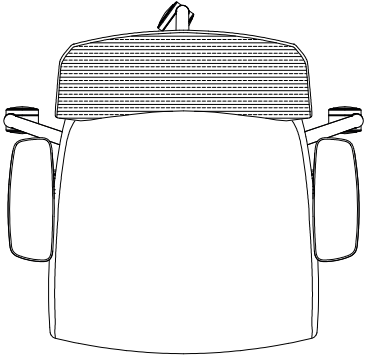

46-49

64,5

Renk Seçenekleri

suni deri

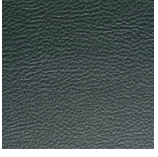

A 208
yeşil | green

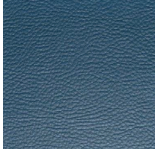

A 206
petrol mavi |
petrol blue

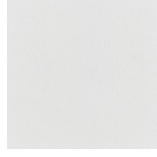

A 101
beyaz | white

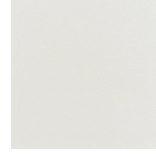

A 102
açık krem |
light cream



A 104
ceviz | walnut

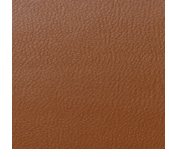

A 105
taba | ginger



A 110
antrasit | anthracite



A 111
koyu kahve |
dark brown

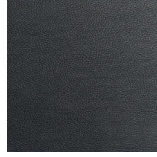

A 112
siyah | black

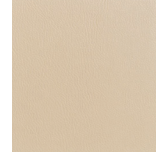

A 113
koyu bej | dark beige



A 114
gri | grey

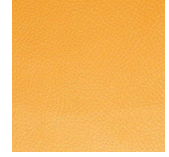

A 201
hardal | mustard

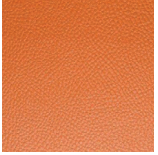

A 202
turuncu | orange

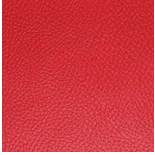

A 203
kırmızı | red

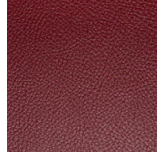

A 204
bordo | bordeaux

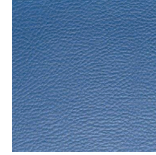

A 205
mavi | blue

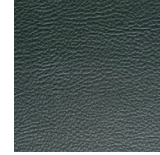

A 208
yeşil | green

bloom kumaş



BL 2302
turuncu | orange



BL 2305
sarı | yellow



BL 2310
kırmızı | red



BL 2315
antrasit | antrachite

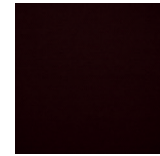

BL 2316
koyu kahve |
dark brown

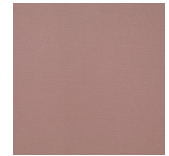

BL 2322
somon | salmon



BL 2324
açık gri | light grey



BL 2334
mint yeşili |
mint green



BL 2327
siyah | black



BL 2338
mavi | blue



A 110
tomurcuk yeşili |
bright green

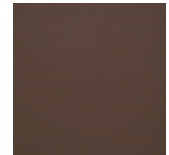

BL 2409
açık kahve | light brown

Renk Seçenekleri

panama

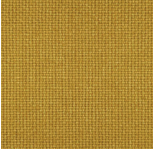

P 101
sarı | yellow



P 104
kırmızı | red

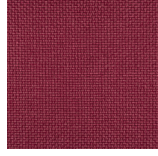

P 106
bordo | burgundy

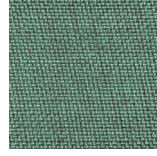

P 110
yeşil | green

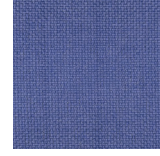

P 113
saks mavi | blue

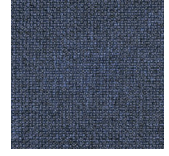

P 114
lacivert | dark blue

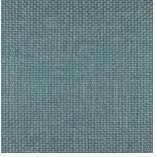

P 111
turkuaz | turquoise



P 108
hardal | mustard

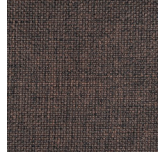

P 109
koyu kahve |
dark brown

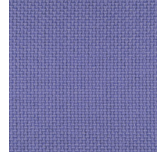

P 307
lila | lilac

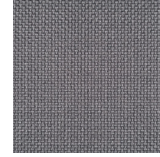

P 308
antrasit | anthracite



P 115
siyah | black

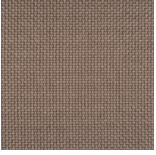

P 301
açık kahve |
light brown

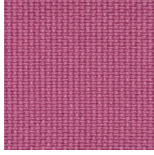

P 302
pembe | pink

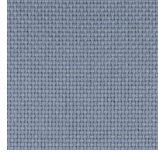

P 303
açık mavi |
light blue

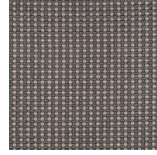

P 401
punti kahve |
punti brown

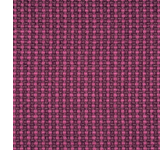

P 402
punti pembe |
punti pink

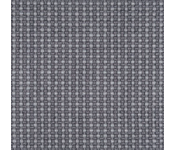

P 403
punti gri | punti grey

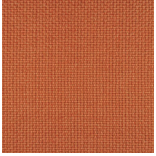

P 102
turuncu | orange

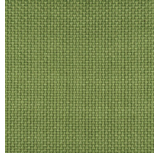

P 305
fıstık yeşili |
pistachio

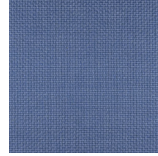

P 112
buz mavi | ice blue

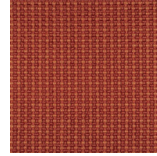

P 404
punti turuncu |
punti orange

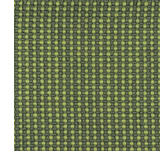

P 405
punti yeşil |
punti green

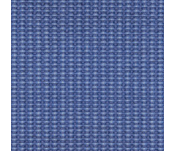

P 406
punti mavi | punti blue

file

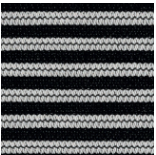

F 700
siyah | black

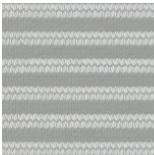

F 701
gri | grey

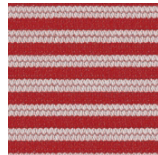

F 702
kırmızı | red



F 703
mavi | blue

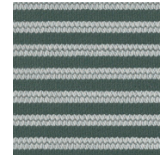

F 704
petrol mavi | petrol blue

Renk Seçenekleri _____

aspect



ACT 02
turuncu | orange



ACT 03
kırmızı | red



ACT 04
bordo | burgundy



ACT 05
roza | rosa

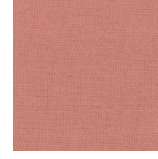

ACT 07
pembe | pink



ACT 08
karamel | caramel



ACT 11
açık kahve |
light brown



ACT 13
sarı | yellow



ACT 15
kahve | brown



ACT 17
adaçayı | sage



ACT 18
zeytin yeşili | olive



ACT 20
mint yeşili |
mint green



ACT 21
fıstık yeşili |
pistachio

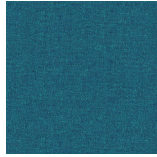

ACT 23
turkuaz | turquoise



ACT 24
lacivert | dark blue



ACT 26
denim | denim



ACT 27
mavi | blue

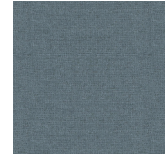

ACT 28
gri | grey



ACT 29
füme | smoked



ACT 30
antrasit | anthracite



ACT 31
siyah | black