

RONIN

by

bürotime

teknik doküman

# RONIN



Utkan Kızıltuğ

“Ronin, adını Japonca kelime anlamıyla “ro + nin”, “dalga adam” anlamına gelen, herhangi bir yere, kişiye bağlı kalmadan özgür gezen savaşçılardan alıyor. Ronin’in düzen dışı duruşu, 12-18. yüzyılın uzak doğusunu hatırlatır biçimselliği, sıra dışı mühendislik çözümü ve masalsı yapısı ofisinizde bütünselliği sağlayan zıt öğelerin birlikteliğini betimlerken, el işçiliğiyle itina ile sarılan deri kol detayları tasarım dilinde yansıtılmak istenen özenli çalışmayı simgeliyor. Koltuğun vücut yapısını destekleyen ergonomik formu oturum esnasında kullanıcıda güven duygusunu artırıyor.”



Güçlü ve kendinden emin formuyla dikkatleri üzerine çeken Ronin; farklı sırt yükseklikleri ve detaylarıyla, yönetici ve toplantı odalarından bekleme alanlarına kadar tüm ihtiyaçlara çözüm sunarak, ofislerin mimari kurgularında karakteristik bir iz bırakır.





Ronin alıřma koltuęu, sırt sertlięini kullanıcının vucut aęırlıęına gre ayarlayan ve oturma fontunun sırt ile birlikte hareketine imkn veren otomatik senkron mekanizması ile dięer alıřma koltuklarından ayrılır. 20°ye kadar sırt eęimi ve 6°ye kadar oturma eęimine imkan veren aęırlık hassasiyetli mekanizma, beliniz ile oturma fontu arasındaki mesafeyi dengeli bir biimde koruyarak saęlıklı oturma saęlar. 5 farklı aıda sırt kilitlenebilmekle zellięiyle farklı oturma pozisyonlarında st bedeninizi destekler.

## ürün ailesi



yönetici



operasyonel



misafir

## özellik tablosu

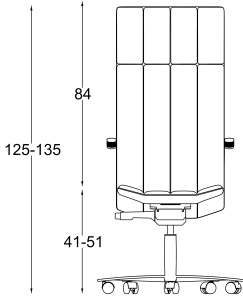

yönetici

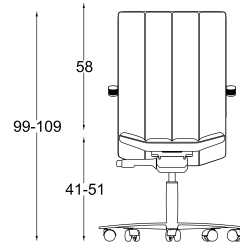
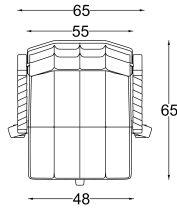
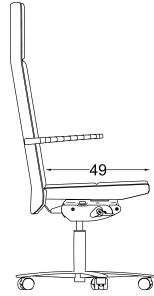

operasyonel

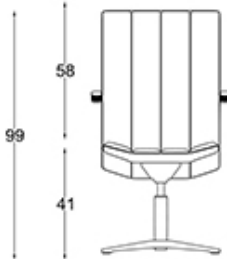
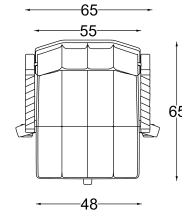
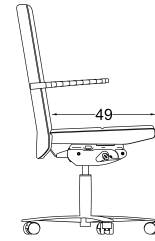

misafir

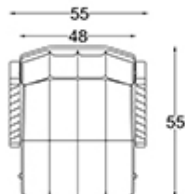

## kol seçenekleri \_\_\_\_\_

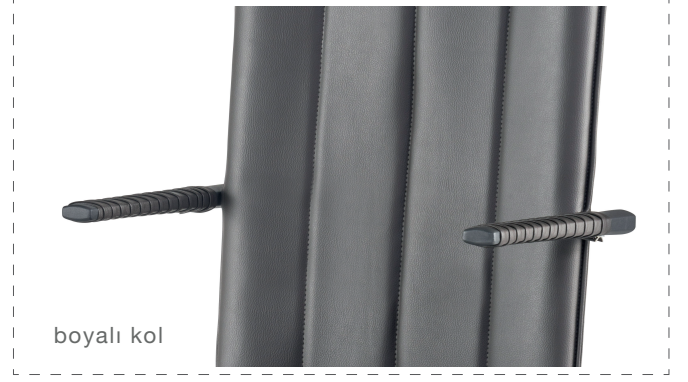
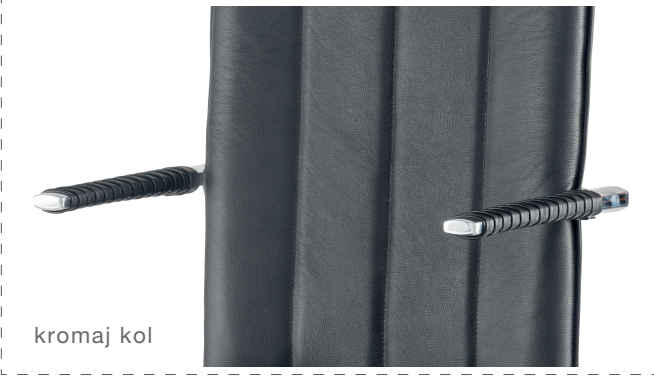

## mekanizma \_\_\_\_\_

### otomatik senkron mekanizma \_\_\_\_\_

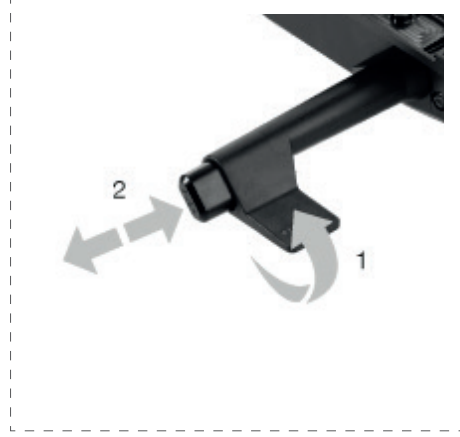

1-Yüksekli ayarı için kolu yukarı doğru çeviriniz.

2-Sirt sabitleme için düğmeye basınız.

## renk seçenekleri

### doğal deri



L 101  
beyaz | white



L 102  
krem | cream



L 103  
açık kahve  
light brown



L107  
koyu kahve  
dark brown



L 104  
bordo | burgundy

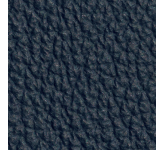

L 106  
lacivert | dark blue

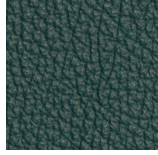

L 105  
yeşil | green



L 108  
siyah | black

### suni deri

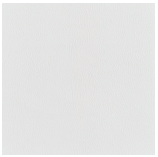

A 101  
beyaz | white



A 201  
hardal | mustard



A 202  
turuncu | orange



A 105  
taba | ginger



A 203  
kırmızı | red



A 104  
ceviz | walnut



A 102  
açık krem | light cream



A 113  
koyu bej | dark beige

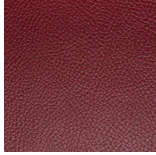

A 204  
bordo | bordeaux

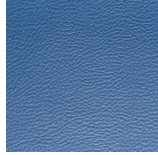

A 205  
mavi | blue



A 114  
gri | grey



A 110  
antrasit | antrachite

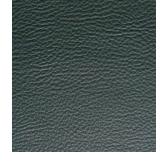

A 208  
yeşil | green

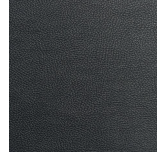

A 111  
koyu kahve | dark brown



A 206  
petrol mavi | petrol blue



A 207  
haki | khaki



A 112  
siyah | black

### metal



beyaz | white

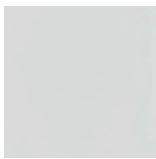

gri | grey

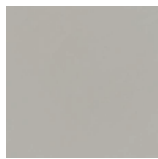

kum | sand

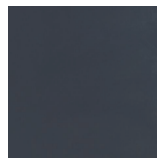

antrasit | antrachite



siyah | black