

BISTRODERN
by
bürotime

technical document



BISTRODERN



Utkan Kızıltuğ - Arif Akıllılar

“In situations that require sharp, rapid, and accurate decisions to be made, a person needs self-confidence. Confidence is a necessary need of the brain, which sets it free, allows ideas for the future to blossom. Designed with this point of view, Bistrodern holds the modern attitude of both the past and the future.”

Having a stylistic power that can make its user feel different, special and important, Bistrodern Meeting Series is quite striking with elaborately thought out details. While it explicitly demonstrates the relationship among the different forms in its foot section, it directly gives out a sense of safe, static stance.



The tipping points that have an important role in such a big table when it comes to statics are hidden with engineering details that are masterfully resolved.



product family _____

square meeting table



rectangular meeting table



eliptic meeting table



cabinet



trolley



size chart

square meeting table

H 73,5 W 140 L 140

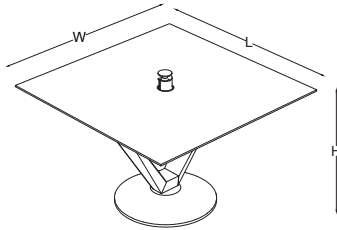

trolley

H 97 W 45 L 103

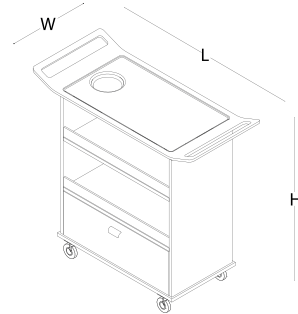

rectangular meeting table

W 140 L 440

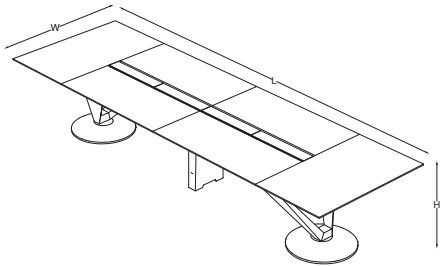

rectangular meeting table

W 140 L 580

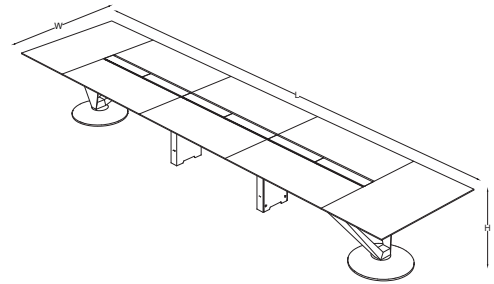

elliptic meeting table

W 153,5 L 400

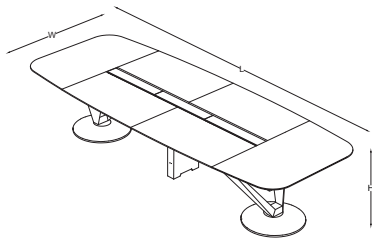

elliptic meeting table

W 157 L 480

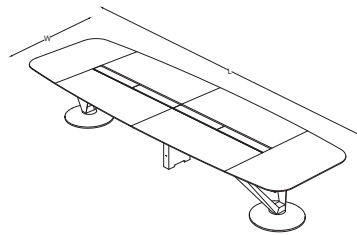

elliptic meeting table

W 157 L 640

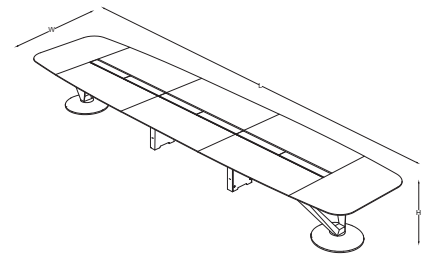

cabinet

L 102,5

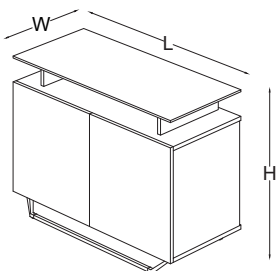

cabinet

L 153,5

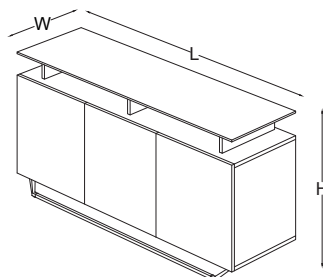

cabinet

L 204,5

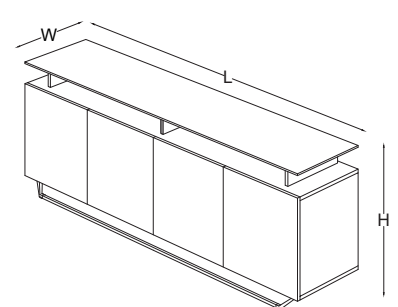

H 73,5

H 73,5

H 72
W 45

color options - desk _____

mdf (top)



oleaster



ash oak



hazelnut



acacia



natural oak



african oak

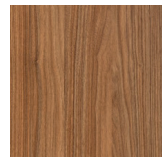

samba walnut

metal (leg)



white



grey

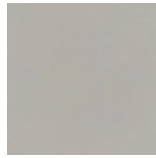

sand



anthracite



black

metal (leg plate)

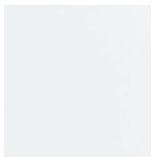

white

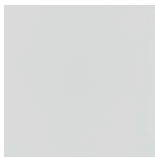

grey

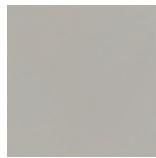

sand

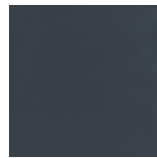

anthracite



black



chrome

lacquer (power socket box)



white

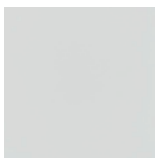

grey

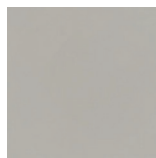

sand



anthracite

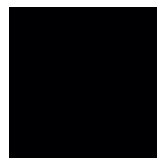

black

cabinet _____

melamine (body - drawer surface)

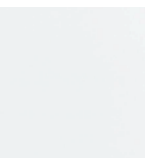

white

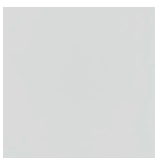

grey

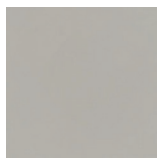

sand

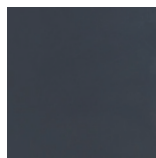

anthracite



black

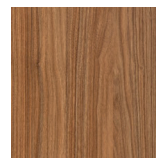

samba walnut



oleaster

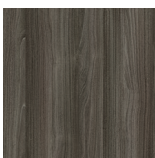

ash oak

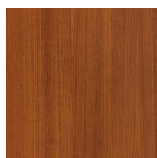

hazelnut

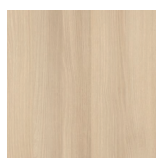

acacia

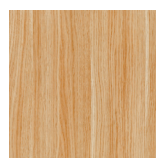

natural oak

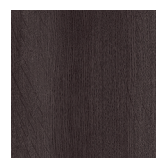

african oak

color options - cabinet _____

mdf (top)

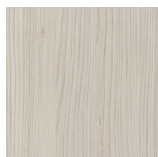

oleaster

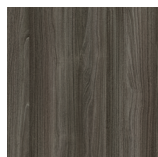

ash oak

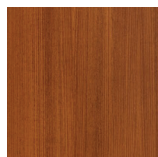

hazelnut

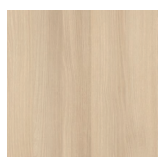

acacia

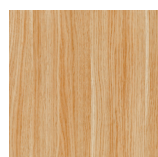

natural oak



african oak

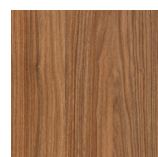

samba walnut

metal (leg color)

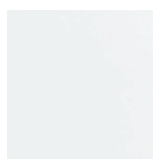

white



grey

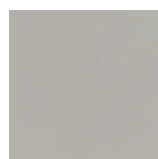

sand

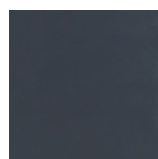

anthracite



black

trolley _____

melamine (body - drawer surface - shelf)

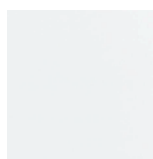

white



grey

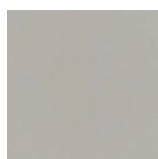

sand

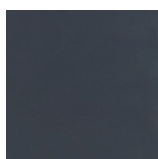

anthracite



black

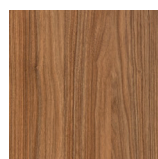

samba walnut



oleaster



ash oak



hazelnut



acacia



natural oak

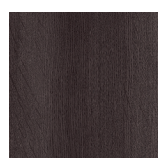

african oak

plexiglass

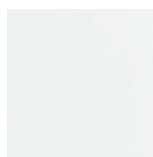

white

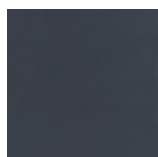

smoked

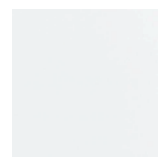

white



grey



black

metal (handle)
